

**OLYMPUS**<sup>®</sup>

Your Vision, Our Future

Microscope Digital Camera

**DP27**

High Resolution And Accurate Colors For Documentation

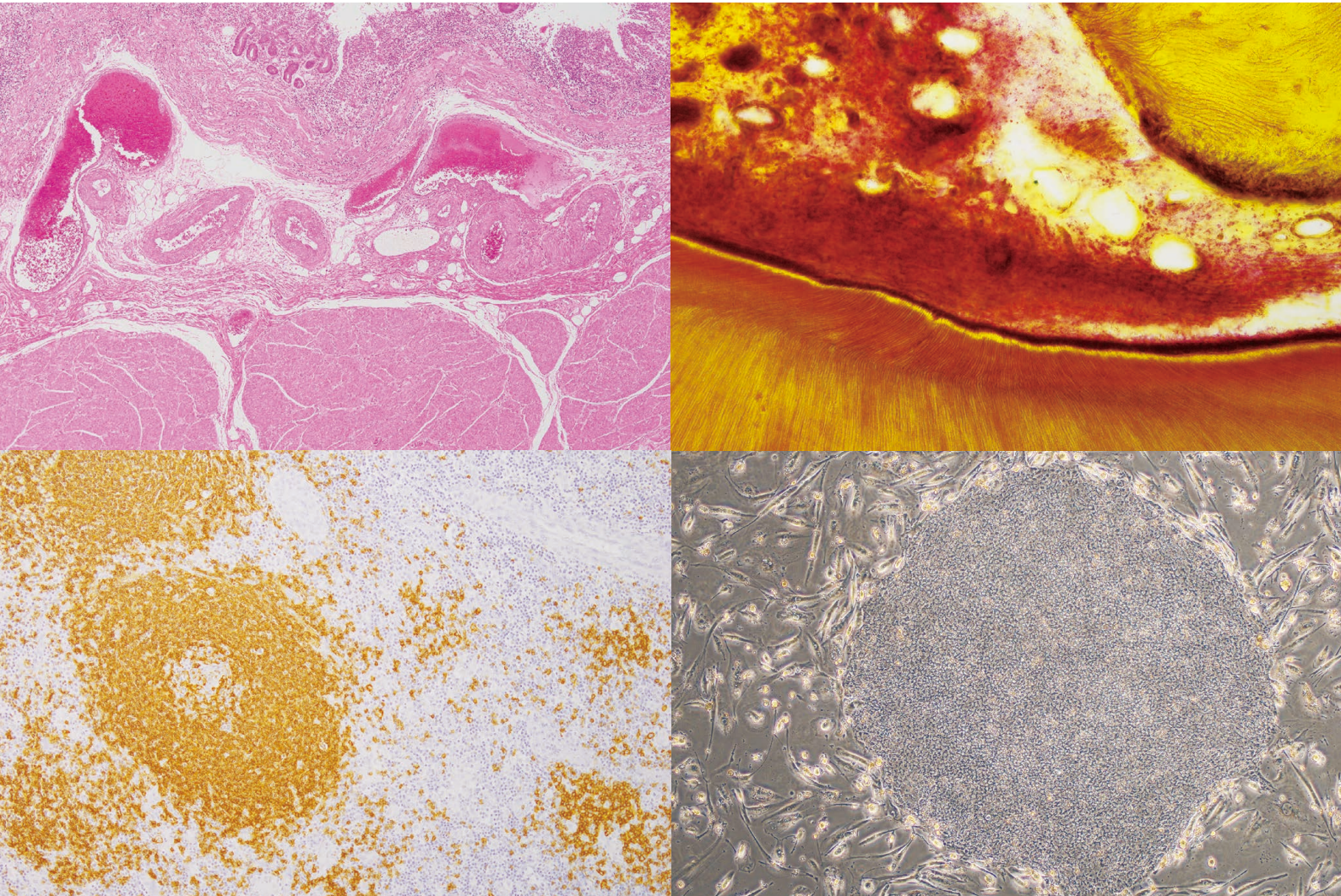

Not for clinical diagnostic use.



High Image Quality And Reliable Color Reproduction With  
5.05-Megapixel High-Resolution CCD.  
Streamline Documentation Procedures With High Frame-Rate Live Capture.

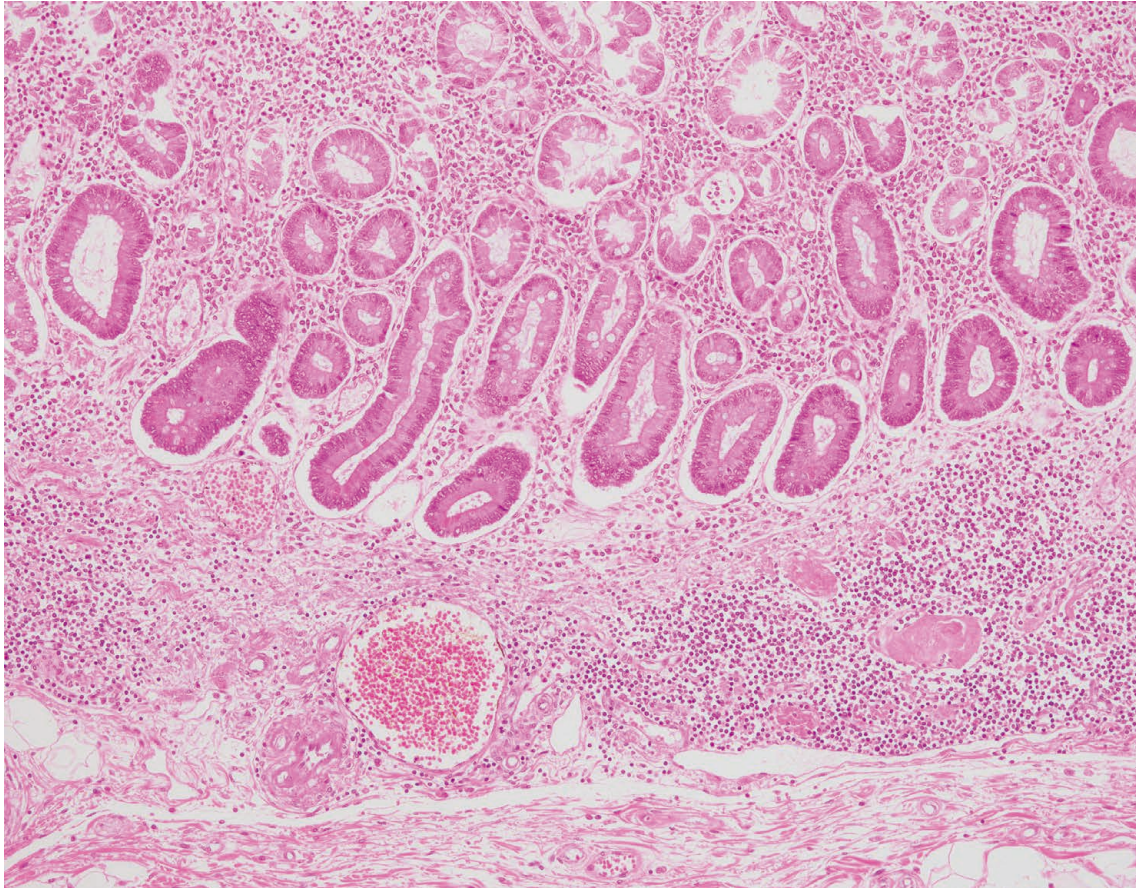

## High Quality Image Design Optimized For Documentation

### © 5.05-Megapixel High-Definition CCD

Equipped with an exceptional 5.05-megapixel CCD, the DP27 digital camera captures images at up to 2448 x 1920 pixel resolution. Large areas captured at low magnification offer exceptionally vivid clarity, even when enlarged several times.

### © Excellent Color Reproduction

Precise reproduction of fine structures and subtle color differences allows areas of interests on the monitor to be identified with an accuracy equivalent to observation through microscope.

### © 15 Frames Per Second Under High Resolution

DP27 provides a fast and smooth live image at the 5.05 megapixel resolution, for quick and effortless panning and focusing. Even when working at Full HD resolution, a comfortably fast live image at 22 frames per second is available. As the non-compressed image is able to reproduce images with absolutely no degradation in quality, operators make simple focusing and framing.

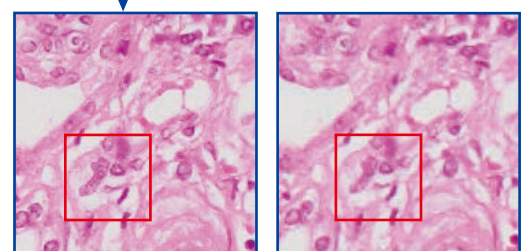
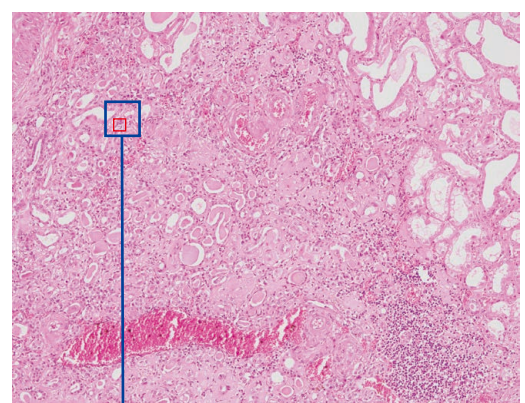

5M Detailed structure can be observed.

2M





### ◎ Three Color Modes

Three color modes are provided, enabling the operator to tailor the image to suit the requirements of different applications. By selecting one of the three preset modes, optimum images can be acquired under various samples and observations without having to change all the settings each time.

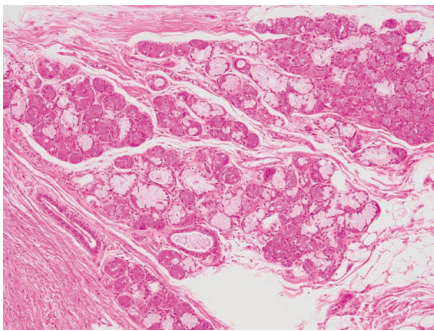

High fidelity mode

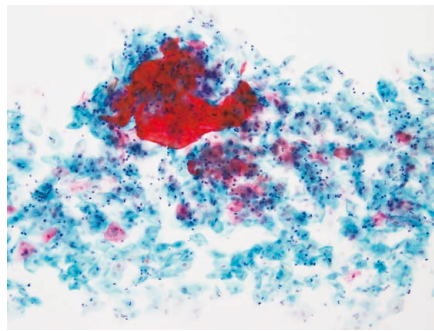

Normal mode

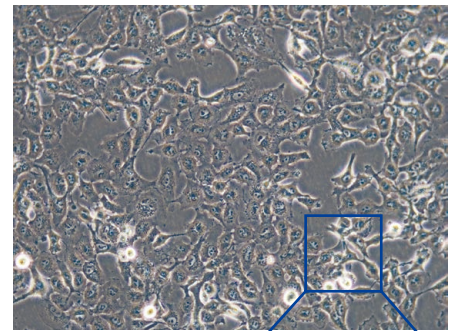

Cell culture mode

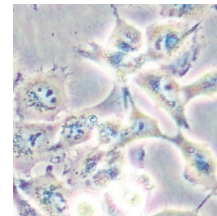

Conventional mode

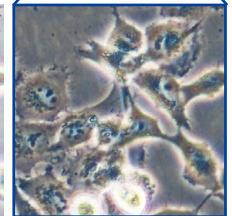

Cell culture mode:  
Halation is reduced to allow clear observation of cell shapes.

- **High fidelity mode** : Reliable color reproduction equivalent to microscope observation.
- **Normal mode** : Enhanced color facilitates acquisition of even pale stained specimens.
- **Cell culture mode** : Dedicated to phase contrast and DIC observations.

## Superior Functionality And Enhanced Scalability Give You More Flexibility And Operational Convenience

### ◎ cellSens Imaging Software (Not For Clinical Diagnostic Use.)

Adjust white balance, switch to live display and capture images, all at the touch of a button. cellSens offers an array of image processing capabilities, including a versatile shading function that enables real-time correction for variations in peripheral field illumination intensity. In addition, exposure settings, magnifications, and other parameters are saved with acquired images for easy storage and retrieval.

The innovative cellSens software offers a wide array of useful and easy-to-use functions. Split-screen display, for example, provides simultaneous viewing of multiple images, or a live image and the most recently captured image. Pictures taken at adjacent locations can also be stitched together to create a single image using the Multi-Image Array functionality. cellSens software has the capability to store user comments with captured images, which can be referred to as necessary or searched using the cellSens Database.

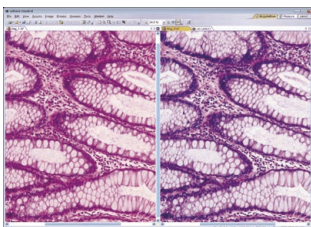

Split-screen Display

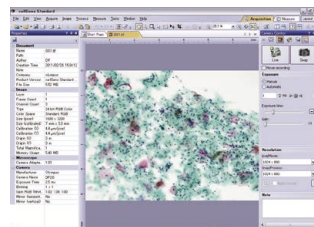

File management

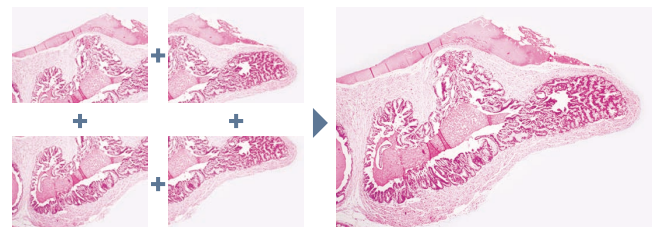

Automatic & Manual Image Stitching

### ◎ Easy USB 3.0 Connection

The DP27 is compliant with the USB 3.0 standard for quick connection to compatible computers and fast transfer of image data.

## Flexible Design With Stand-Alone Operation Capability

### ◎ Simple, Space-Saving Stand-Alone Connectivity

While PC-connected operation provides optimal functionality and scalability, the DP27 can also function effectively in a stand-alone configuration, which features simple operation and easy control from mouse, keyboard or touchscreen monitor.

## DP27 PC configuration system diagram

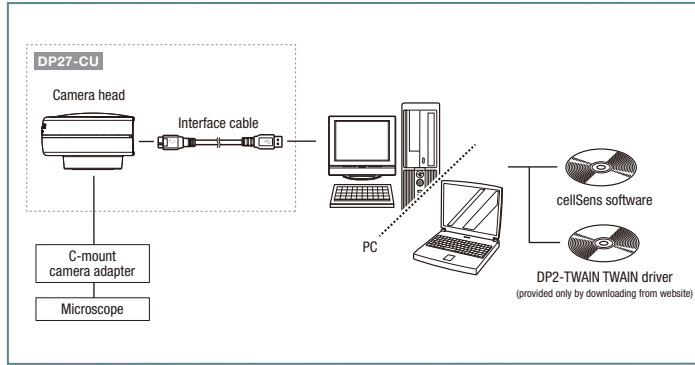

## DP27 Specification

Type	Single chip color CCD camera
Imaging sensor	Size: 2/3 inch color CCD
	Effective pixels: 5.05 megapixels (total: 5.24 megapixels)
	Scanning method: Progressive scanning
	Color filter: RGB primary color on-chip filters
	Recording area: 8.4(H) × 6.62(V) mm, diagonal length 10.73 mm
	Maximum recorded pixels: 4.7 megapixels (2448 × 1920)
Mount	C-mount
Sensitivity	Equivalent to ISO 100/200/400
Metering Area	Full image / 30% / 1%
Exposure control	Auto/Manual AE lock (enabled when Auto Exposure is selected) Exposure compensation : Area -2EV to +1EV, +side:1/6EV step, - side:1/3EV step (enables when Auto Exposure is selected.)
Exposure time	Auto: 1/20,000s to 2s Manual: 1/20,000s to 8s
Camera I/F	USB3.0 Micro-B
Dimension	Camera Head: 77 (W) × 69.5 (D) × 42.5 (H) mm Control Unit: 180 (W) × 200 (D) × 47 (H) mm

## DP27 stand-alone configuration system diagram

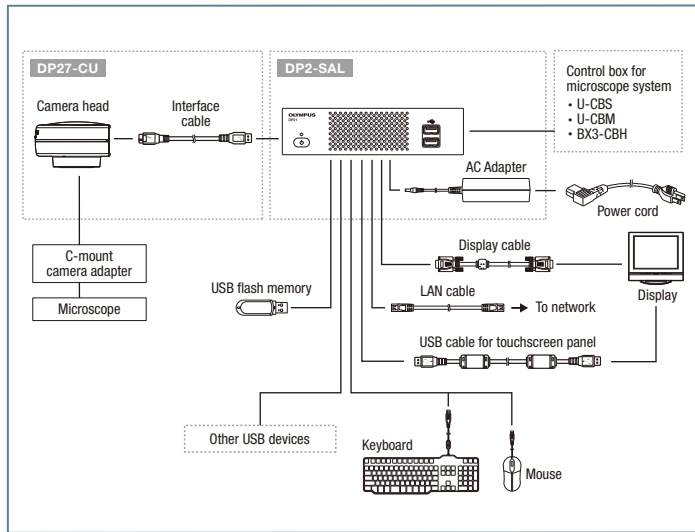

	PC connection	Stand-alone	
Image size	2448 × 1920	2448 × 1920	
	1920 × 1080 (Full HD)	1920 × 1080 (Full HD)	
	1224 × 960	1224 × 960	
Live image display (frame rate)	15fps (2448 × 1920)	15fps (2448 × 1920)	
	22fps (1920 × 1080)	22fps (1920 × 1080)	
	30fps (1224 × 960)	30fps (1224 × 960)	
Compatible image display		1920 × 1200 WUXGA	
		1920 × 1080 Full HD	
		1680 × 1050 WSXGA+	
		1600 × 1200 UXGA	
		1280 × 1024 SXGA	
		1280 × 960 QVGA	
		1280 × 854 WXGA	
		1280 × 768 WXGA	
	1024 × 768 XGA		
	1024 × 600 WSVGA		
	800 × 480 WVGA		
Storage media	—	USB flash memory, USB-HDD	
Controller interface	USB 3.0 (+5V / 900mA power output)	Camera I/F: USB 3.0 Type-A Display output: DVI-I (Digital/Analog RGB) I/F: USB 2.0 × 4, USB 3.0 × 1 Wired LAN: 100Base-TX/10Base-T Serial port: RS-232C D-Sub 9-pin Audio: Mic in, Line out*	
	Scale display	According to cellSens* specifications	Scale view & burn in can be selected Available microscope total magnification: 0.01× to 9999.99× Up to 28 total magnifications can be memorized
	Measuring functions	According to cellSens* specifications	Distance of 2 Points, 3 Points Circle, Distance between 2 Circle Centers, 3 Points Angle, 4 Points Angle, Perpendiculars, Polygon Area, Boundary Length, Distance of Parallel Lines, XY Distance, Count, Poly Line, and Cross Line

\* cellSens software is not for clinical diagnostic use.

Image data courtesy of:  
"Human iPS Cell colony"  
Isao Asaka  
Center for iPS Cell Research and Application, Kyoto University  
(lower right, cover page)

[www.olympus-lifescience.com](http://www.olympus-lifescience.com)

**OLYMPUS**

For enquiries - contact  
[www.olympus-lifescience.com/contact-us](http://www.olympus-lifescience.com/contact-us)

**OLYMPUS CORPORATION**  
Shinjuku Monolith, 2-3-1 Nishi-Shinjuku, Shinjuku-ku, Tokyo 163-0914, Japan  
**OLYMPUS EUROPA SE & CO. KG**  
Wendenstrasse 14-18, 20097 Hamburg, Germany  
**OLYMPUS SCIENTIFIC SOLUTIONS AMERICAS CORP.**  
48 Woerd Avenue, Waltham, MA 02453, U.S.A.  
**OLYMPUS SINGAPORE PTE LTD.**  
491B River Valley Road, #12-01/04 Valley Point Office Tower, Singapore 248373  
**OLYMPUS MEDICAL SYSTEMS INDIA PRIVATE LIMITED.**  
102-B, First Floor, Time Tower, M.G. Road, Gurgaon 122001, Haryana, INDIA

**OLYMPUS LATIN AMERICA, INC.**  
5301 Blue Lagoon Drive, Suite 290 Miami, FL 33126, U.S.A.  
**OLYMPUS (CHINA) CO., LTD.**  
ABF, Ping An International Financial Center, No. 1-3, Xinyuan South Road, Chaoyang District, Beijing, 100027 P.R.C.  
**OLYMPUS KOREA CO., LTD.**  
8F Olympus Tower, 446 Bongseunsa-ro, Gangnam-gu, Seoul, 135-509 Korea  
**OLYMPUS AUSTRALIA PTY. LTD.**  
3 Acacia Place, Notting Hill VIC 3168, Australia

- OLYMPUS CORPORATION is ISO14001 certified.
- OLYMPUS CORPORATION is ISO9001 certified.
- All company and product names are registered trademarks and/or trademarks of their respective owners.
- Images on the PC monitors are simulated.
- Specifications and appearances are subject to change without any notice or obligation on the part of the manufacturer.